

MODULAR-KART™ ASSEMBLY INSTRUCTIONS

K3624B and KT3624B

Available in Grid or Solid Top

COMPONENTS:

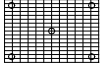

Panels: (2) 2'x3'
 Legs: (4) 24"
 Internal Stackers: (4)
 Casters: (4)

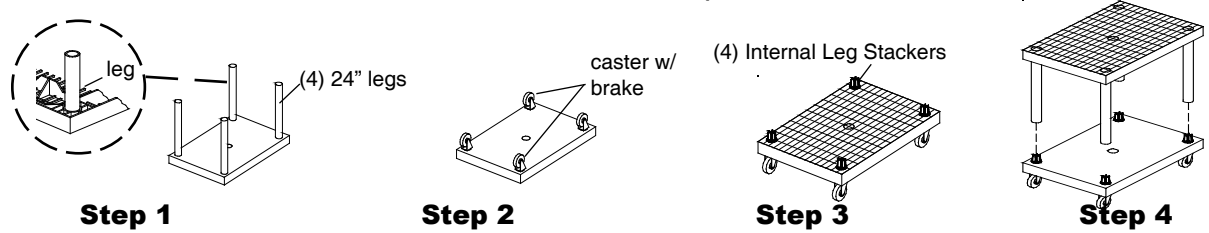

COMPONENTS:

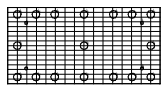

Panels: (2) 2'x4'
 Legs: (6) 24"
 Internal Stackers: (6)
 Casters: (6)

K4824B and KT4824B

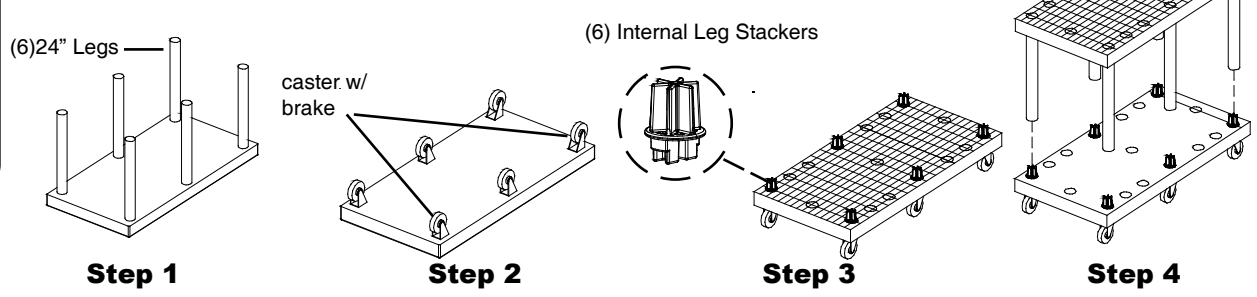

COMPONENTS:

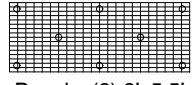

Panels: (2) 2'x5.5'
 Legs: (6) 24"
 Internal Stackers: (6)
 Casters: (6)

K6624B and KT6624B

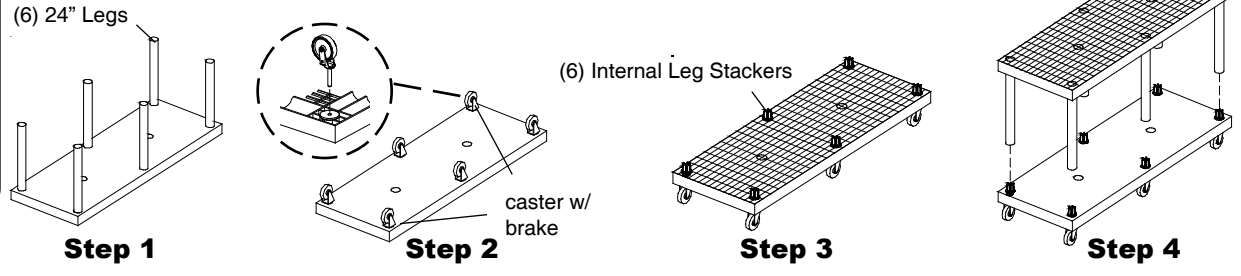

COMPONENTS:

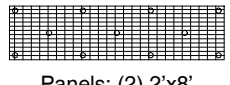

Panels: (2) 2'x8'
 Legs: (8) 24"
 Internal Stackers: (8)
 Casters: (8)

K9624B and KT9624B

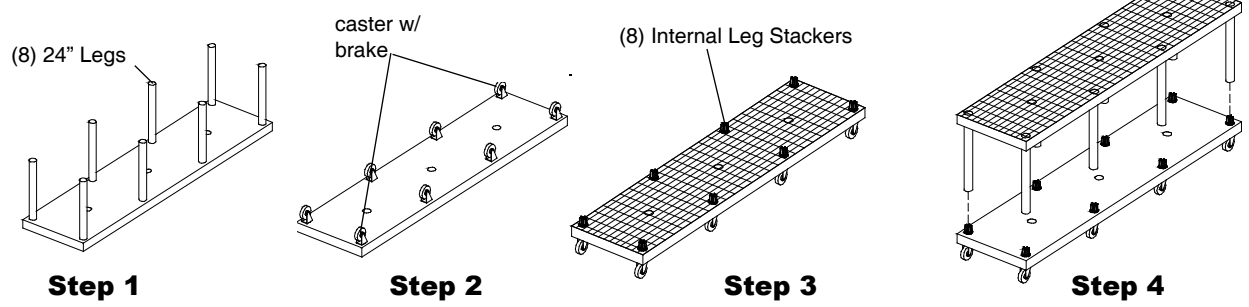

Step 1
 Lay one of the Kart panels up-side-down on the floor and insert 24" posts into sockets as shown. Return to upright position.

Step 2
 Invert the next Kart panel on the floor and insert **Casters** into sockets as shown. Place **Casters with Brakes** in opposite corners. Return to upright position.

Step 3
 Insert **Internal Leg Stackers** over outside row sockets of Kart panel with Casters as shown.

Step 4
 Align Kart panel with posts over the leg stackers and push all the way down until the leg stackers are inserted into the posts.

MODULAR-KART™ ASSEMBLY INSTRUCTIONS

K3624A

COMPONENTS:

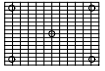

Panels: (1) 2'x3'
Legs: (4) 24"
Internal Stackers: (4)

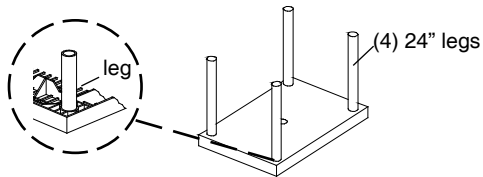

Step 1

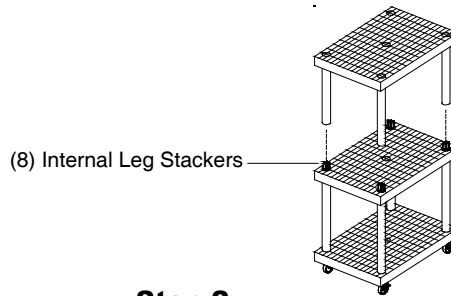

Step 2

K4824A

COMPONENTS:

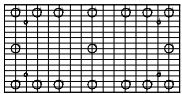

Panels: (1) 48"x24"
Legs: (6) 24"
Internal Stackers: (6)

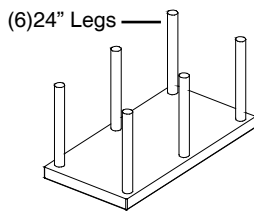

Step 1

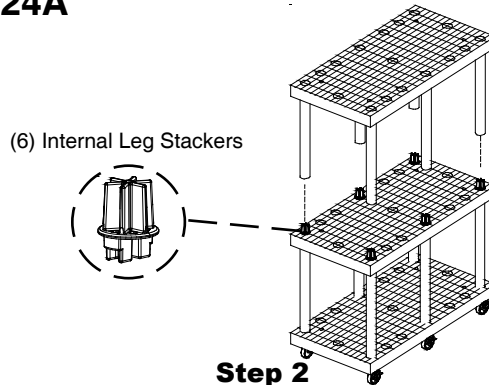

Step 2

K6624A

COMPONENTS:

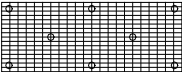

Panels: (1) 2'x5.5'
Legs: (6) 24"
Internal Stackers: (6)

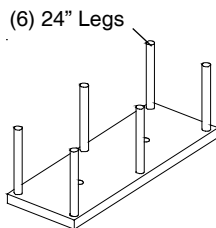

Step 1



Step 2

K9624A

COMPONENTS:

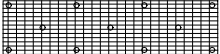

Panels: (1) 2'x8'
Legs: (8) 24"
Internal Stackers: (8)

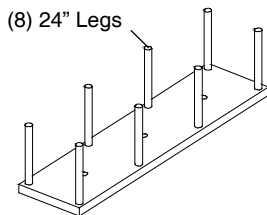

Step 1

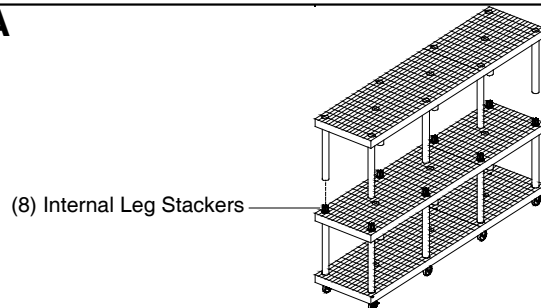

Step 2

Step 1

Lay one of the Kart panels up-side-down on the floor and insert 24" posts into sockets as shown. Return to upright position.

Step 2

Invert the next Kart panel on the floor and insert **Casters** into sockets as shown. Place **Casters with Brakes** in opposite corners. Return to upright position.

ASSEMBLY INSTRUCTIONS

2- Options to Secure Legs to Panels

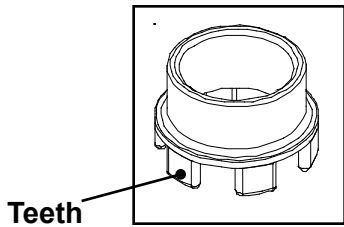

Leg Collar

How to use the Leg Collar

First, place the collar over socket aligning teeth of collar to fit through grids.

Second, Leg is inserted into the leg collar.

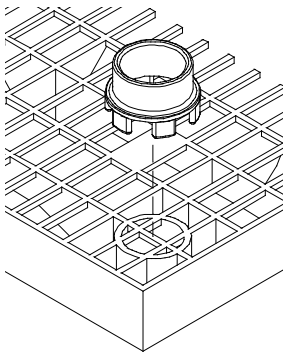

Collar Placement

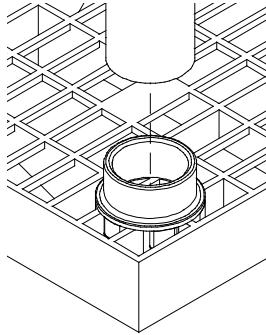

Leg Placement on Collar

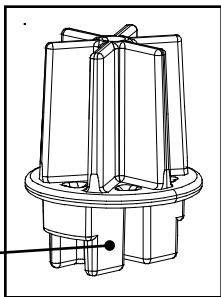

Internal Leg Stacker

How to use the Internal Leg Stacker

First, Place the stacker over socket aligning the prongs with the D-shaped holes, and push down.

Second, leg is inserted over the leg stacker.

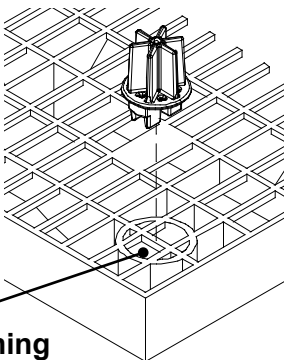

Internal Leg Stacker Placement

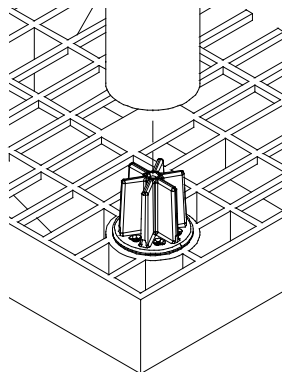

Leg Placement on Internal Leg Stacker